

# Product Specification

Item Code:  
**TP349**

Product Name:  
**Food 8°C/46°F**



## General:

Food is a Timestrip® temperature indicator that shows how long your product has been above threshold temperature (8°C/46°F).

Inert until activated and self-adhesive, it can be stored at room-temperature then stuck to a product or package when needed (see Appendix 1 for adhesive details). It is single use and indication is irreversible. It is splashproof and there is an expiry date on each pack shipped.

## How to Use

The indicators are completely inert prior to activation and can be stored at room temperature.

To activate **Food** the surrounding temperature must be at or above the threshold temperature of 8°C so that the blue liquid can be released from the button. Fully squeeze the button and check that the word 'On' appears. If not, immediately re-squeeze the button fully. Within 2-3 minutes of activation, place the indicator below its STOP temperature for a minimum of 1 Hour so that the liquid freezes and the indicator is fully conditioned and ready to use. If the carrying card or the product to be monitored is already at or below the STOP temperature then the indicator can be stuck directly to it by removing the adhesive liner on the back.

Threshold Temp	Stop temp*	Run-Out window**	Time Marks in Hours
+8°C/+46°F	+6°C/+43°F	4 Hours	1/2, 2 & 4

\* The temp at which the run-time advancement (the movement of the blue dye) will stop.

\*\* The run-out window is calibrated to an isothermal temp of +2°C above the stated/printed Threshold temp.

## I) Performance Specifications:

- Temp Accuracy:  $\pm 1^{\circ}\text{C}/2^{\circ}\text{F}$
- Time Accuracy:  $\pm 15\%$  in time under isothermal conditions
- Progress Isotherms: See Fig. 1
- Display: Continuous, irreversible
- Usage: The usage of the product in any assembly or production line must be agreed upon in advance, as it may alter performance specifications.

## II) Product Specification:

- Button Position: Button on Top (BOT)
- Colour of Progressing Front: Blue
- Adhesive: #2641, Pressure sensitive,  $-40^{\circ}\text{C}$  to  $+110^{\circ}\text{C}$ , Finger lift – See Appendix 1
- Product drawing: See Fig. 2
- Graphics: See Fig. 3
- Other: Not suitable for immersion in water
- Remark: Run-time window length will vary slightly between production batches.

## III) Product Construction:

The indicator is constructed of polymeric assembly multilayer and aluminium-plastic laminate. It encapsulates coloured liquid chemicals\*.

\* Maximum weight of colorant is  $<0.5$  mg.

\*\* Liquid chemicals are listed in the Food Chemicals Codex and/or approved by the Food and Drug Administration (FDA) under Title 21, and/or considered generally recognized as safe (GRAS).

\*\*\* All materials are non-toxic, latex, silicon and PVC free.

## IV) Storage Conditions (un-activated):

- Store in a cool dark environment away from heat sources.
- Recommended:  $22^{\circ}\text{C}/72^{\circ}\text{F}$  at 20-80% RH.
- Please note that before activation, the product can tolerate short term exposure during transit (hours or a few days) to temperatures in the range  $-30^{\circ}\text{C}$  to  $+55^{\circ}\text{C}$ . However, long term storage should be under recommended conditions.

## V) Shelf-life:

- 2 Years – an expiry date is stated on each pack.

**Fig 1: Progress Isotherm**

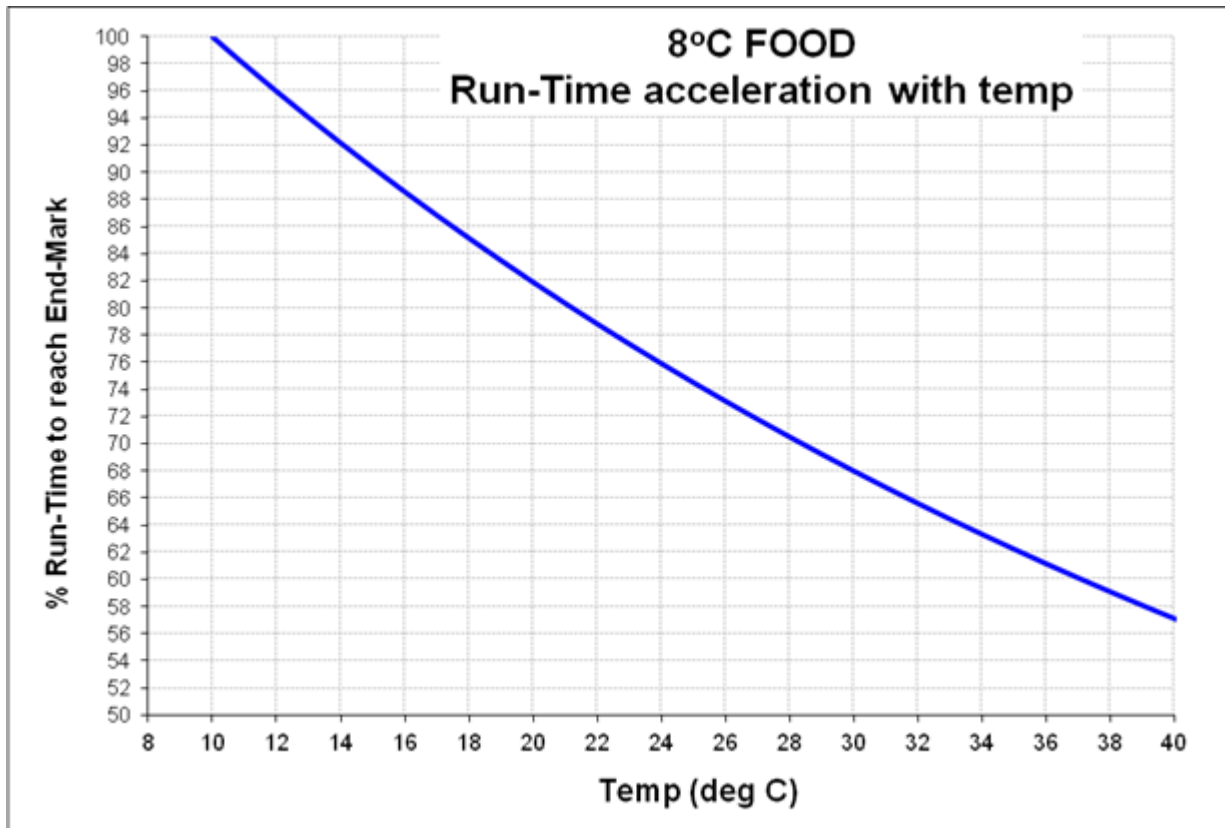

**Fig 2: Product Drawing**

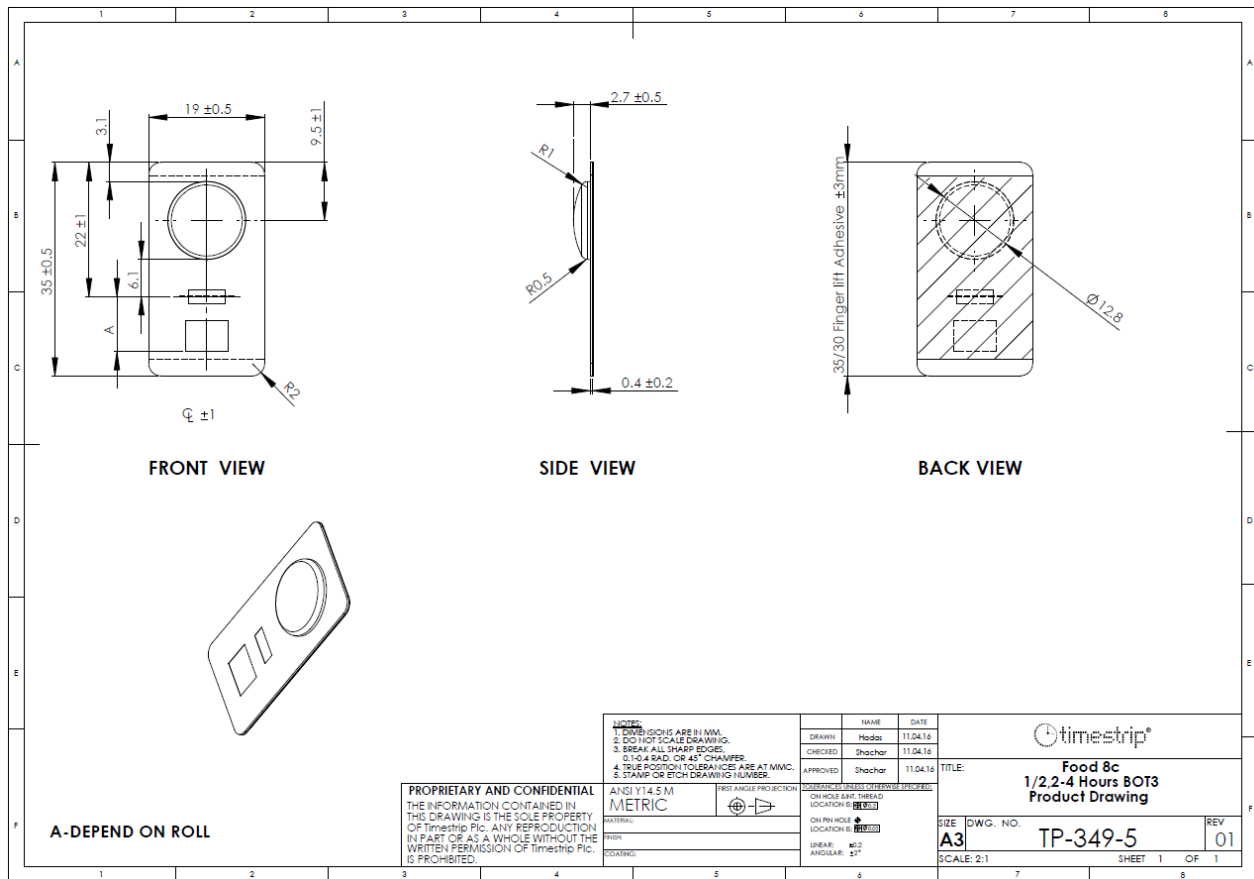

**Fig 3: Graphics**

100%





Before  
Activation

Activated

1/2 Hours Above  
Threshold Temperature







2 Hours Above  
Threshold Temperature

4 Hours Above  
Threshold Temperature







200%

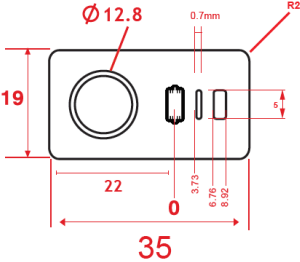

Pantone 2756 EC		TS 2735
Pantone 294		TS 654
Pantone 7459 EC		TS 7459
		P485 ec
Pantone 536 EC		
Pantone Process Blac EC		
Pantone 2756 EC		TS Pantone 2735 C

**Calibration from ROLL PL381**



**\*For Approval:**

- Print out, sign and Fax to +972-9-8991347 or
- Send a Mail with the approved graphics attached to mail.

Customer approval *			
<b>Name</b>		<b>Title:</b> Food 8/46	
<b>Sign.</b>	Graphic Designer: Hadas 01.03.16 Lin. Tolerance: ±0.5mm.	2/4 Hours BOT	
<b>Date</b>	Drawing No.: Printing DWG:	Graphic no. 800-349	Rev. 1 SH. 1 OF. 1

## Appendix 1

### Pressure Sensitive Adhesive Data

Timestrip Adhesive - Product # 2641

	<u>SUBSTANCE</u>		<u>THICKNESS</u>
Adhesive	40gsm		
Tissue	12gsm	Adhesive & Carrier	95 micron
Adhesive	45gsm		
Liner	80gsm	Liner	70 micron

#### PRODUCT DESCRIPTION

A permanent tape with a tissue carrier. The adhesive is a modified acrylic, offering good UV light and chemical resistance together with high performance especially to difficult surfaces. The liner is a two side release system.

#### APPLICATIONS

The high tack/adhesion of 2641 makes it especially useful for applications involving the bonding of difficult substrates such as many foams, rubbers and polythene type materials. The product is also useful for various mounting applications.

#### ADHESIVE PROPERTIES

		<u>20 min</u>	<u>24 hour</u>	<u>TEST METHOD</u>
Adhesion to steel	open side	1300 N/M	1400 N/M	BS7116:1990 - D
	closed side	1300 N/M	1400 N/M	BS7116:1990 - D
Shear Adhesion	open side	5 hours		BS7116:1990 - B
	closed side	5 hours		BS7116:1990 - B
Release of liner from adhesive		10 N/M		BS7116:1990 - E

#### THERMAL PROPERTIES

Recommended service temperature range	-40°C to 110°C	-40°F to 230°F
Application temperature range	5°C to 60°C	41°F to 140°F

#### SHELF LIFE

Minimum shelf life when stored in closed cartons away from direct sources of heat and sunlight.

2 Years

#### HEALTH AND SAFETY INFORMATION

The adhesive conforms to F&DA Regulation 175.105.

#### Note

Values given are average and should not be taken as a maximum or minimum for specification purposes. Specific technical details, applications information and suggested uses available.

For additional information contact us on:

1, Haatzmut Street, P.O. box 3005, Even Yehuda, 40500, Israel  
Tel: +972-9-8992005 Fax: +972-9-8991347

QA-AD1 12/09

#### Document information

<u>Document Type</u>	<u>Identifying No.</u>	<u>Rev./Issue</u>	<u>Date</u>
Graphics	800-349	01	01.03.16
Product Drawing	TS-349-5	01	11.04.16
Adhesive #2641 Data Sheet	QA-AD1	00	12/2009
Product Specification Sheet	--	00	12.07.16

Issued by: **Reuben Soncino, QA Manager**

Date: **July 12, 2016**

Rev: **00**

Technical queries to: [qc@timestrip.com](mailto:qc@timestrip.com) or UK+44 1223 926075

Sales/general queries to: [info@timestrip.com](mailto:info@timestrip.com) or UK +44 1223 911863

For usage tips go to [www.timestrip.com](http://www.timestrip.com)